

sedus

Table programme

temptation c



Ergonomics start where functionality is achieved.

Movement plays an important role in health and therefore also in performance, which is especially true during working hours. This has been confirmed by recent studies which show how regularly changing one's posture can boost health. The Sedus *temptation c* height-adjustable table systems allow users to work both when standing and seated – precisely this active behaviour.





The customised setting of the seat height or seat/standing height, with height adjustment via either a gas spring or electric motor, guarantees the optimal height for working.

With electromotor height adjustment, the sitting/standing height can be conveniently set at the touch of a button (Fig. left), whereas the gas spring version enables independent adjustment and optimal load setting using a crank handle.



Powerhouse. Whether for daily work tasks or using heavy accessories, e.g., printers and privacy screens, the gas spring is up to the job.

Alongside exemplary ergonomics, this range also boasts clear, aesthetic lines. State-of-the-art features, such as wireless charging, make the *temptation c* one of the leading table systems in its class.

Always the ideal solution for ... seated workplaces

Technology

Telescopic height adjustment or ratchet height adjustment without the need for tools

Crank-operated height adjustment

Recommended for

permanently designated seated workplaces

Seated workplaces as multi-user workstations

Height adjustment range

620 - 850 mm

620 - 850 mm

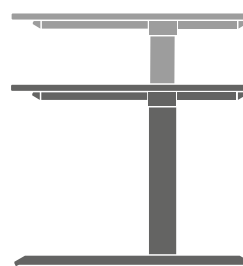
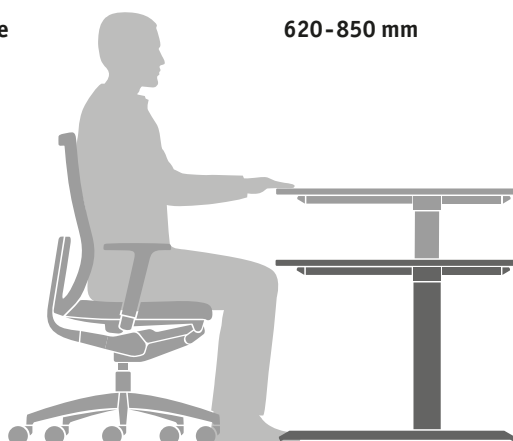

Product name

temptation c

temptation c

Six different versions of height adjustment are available for the *temptation c*; three of which are for seated heights and three for both seated and standing heights. Regardless of which technology you opt for, you will be choosing perfected ergonomics together with unparalleled flexibility.

Height adjustment using tools. Manually adjustable. Benefit: the most cost-effective solution for height adjustment.

Height adjustment without tools. Using a simple 10 mm ratchet setting, this option is extremely user-friendly. Benefit: quick, individual adjustment.



Crank-operated height adjustment. For multi-user workstations, as found in call centres and desk sharing stations. Benefits: simple adjustment, no power connection required.

... seated/standing workstations

Motorised height adjustment, including sensor disconnection

Seated/standing workstations as multi-user stations – particularly suited for special configurations

650 - 1250 mm

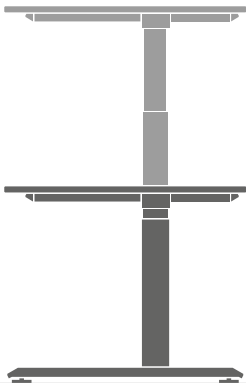

temptation ci

Motorised height adjustment, including sensor disconnection

Seated/standing workstations as multi-user stations – featuring state-of-the-art sensor technology

650 - 1280 mm

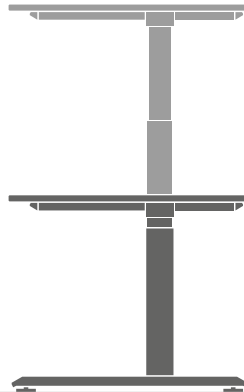

temptation c smart

Gas spring with manual load setting

Seated/standing workstations as multi-user stations – with rapid, intuitive operation, not dependent on a power source

680 - 1180 mm

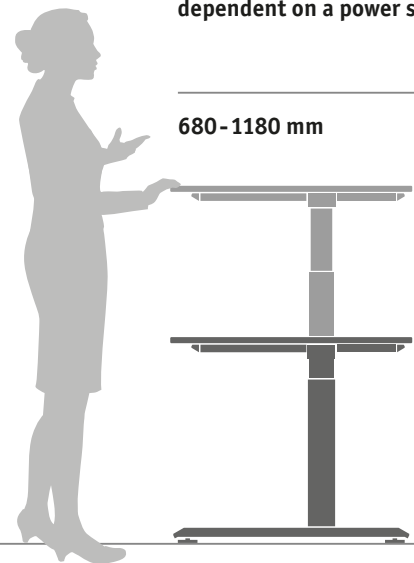

temptation c get up



Electric motor height adjustment with “Up/Down” control element or, optionally, with a digital display and memory function for four preselected heights. Benefits: weight-independent operation, simple adjustment with a power supply, sensor disconnection for sensitive impact protection, low noise generation. The “Up/Down” control element recessed in the desktop is available as an option. As well as providing a clear and modern look, this also makes operation even more intuitive.



Safety as standard. The sensor disconnection monitors the height adjustment of the desktop. In the event of jarring or slight imbalances, adjustment is immediately stopped.



Gas spring height adjustment. Ideal force adjustment using the crank handle for individual setting of the table’s live load of up to +50 kg. Benefits: fast and intuitive adjustment, not dependent on power sources, no costs for stand-by mode and maintenance, no CO₂ emissions due to currentless operation, low noise generation.



Here's to good collaboration.

Together with other Sedus products, *temptation c* offers a wide range of options for customised workplace and room designs. For example, the privacy elements from *se:wall* can also be attached behind a height-adjustable table in order to separate quiet workstations from more lively ones – and these are available in freely selectable working heights. Tall pedestals or Sedus *grand slam z* also provide additional storage space which simultaneously act as a room divider, privacy screen or contact point for brief meetings held whilst standing.



System adapter. It accommodates lights, privacy elements and function bridges to name a few of its uses.



Complementary. The central organisation rail from *se:wall* provides plenty of room for practical accessories. This also includes the option of a power supply via a socket and USB charger.



Practical. The printer shelf, laptop holder and PC housing holder located within easy reach allow individual desks to be customised.



Being organised is half the battle. So you don't lose sight of what matters.

The saying goes that the state of a desk reflects the state of the mind. Sedus *temptation c* features a clear electrical connection concept. All the cables are elegantly concealed in the electrical connection flaps. As the flaps can be easily accessed from above, connecting personal technical equipment is no longer an issue.



A free table. The sliding top allows direct access to the cable tray below the desk. A fixed table top can be fitted with a fold-up cable tray. At the desk, the cables are either guided through the panel on the side or through the cable management system. There is also an elegant round grommet and a handy table-top socket. This makes for an orderly desk.



Elegant. Functional and aesthetically pleasing: the continuous and two-part electrical connection flap renders the cable tray invisible yet still allows easy and convenient access to power and data connections as and when needed. The brushes make it possible to supply cables to any point.

Unobserved. The knee screen made of plexiglass, melamine or real wood veneer protects from prying eyes.



Networker. The flush-mounted socket and induction surface for the wireless charging of smartphones offer additional power supply options.

Flexibility is in the family.

All the tables within the *temptation* family can be harmoniously combined. The ergonomic C-frame tables from *temptation c* work alongside the 4-leg tables from *temptation four*, for example, as work and conference solutions. Thanks to the uniform design, *temptation twin*, *high desk* and *prime* also dovetail seamlessly into the overall look.

The attractive design of the *temptation c* desktop and frame components are guaranteed to enhance the appearance of every room. With numerous attachment and linking elements, the tables can be configured to suit your requirements. This makes it not only economical but also future-proof.

Inviting. A separate meeting table is no longer required; the curve of the table offers enough space and immediately creates an intimate meeting atmosphere.



Generous. The double desk with side return provides a primary worksurface to the front whilst the side of the desk can be used as additional storage space.



Perfect for a good communication style.

The conference tables in the *temptation c* product family are characterised by intelligent functionality and efficiency. Various desktops are available in several sizes, materials and colours. This allows you to create attractive meeting situations to suit all needs and rooms.



Consistent design.

The look and finish match the desks.



The more the merrier. The large boat shape can accommodate up to ten people at a table.



A perfect fit. We also have ideal solutions for smaller meeting rooms.



Communicative. The trapezoidal shape is ideal for using the *monitor caddy*, for example, in training sessions and videoconferences.

Desks

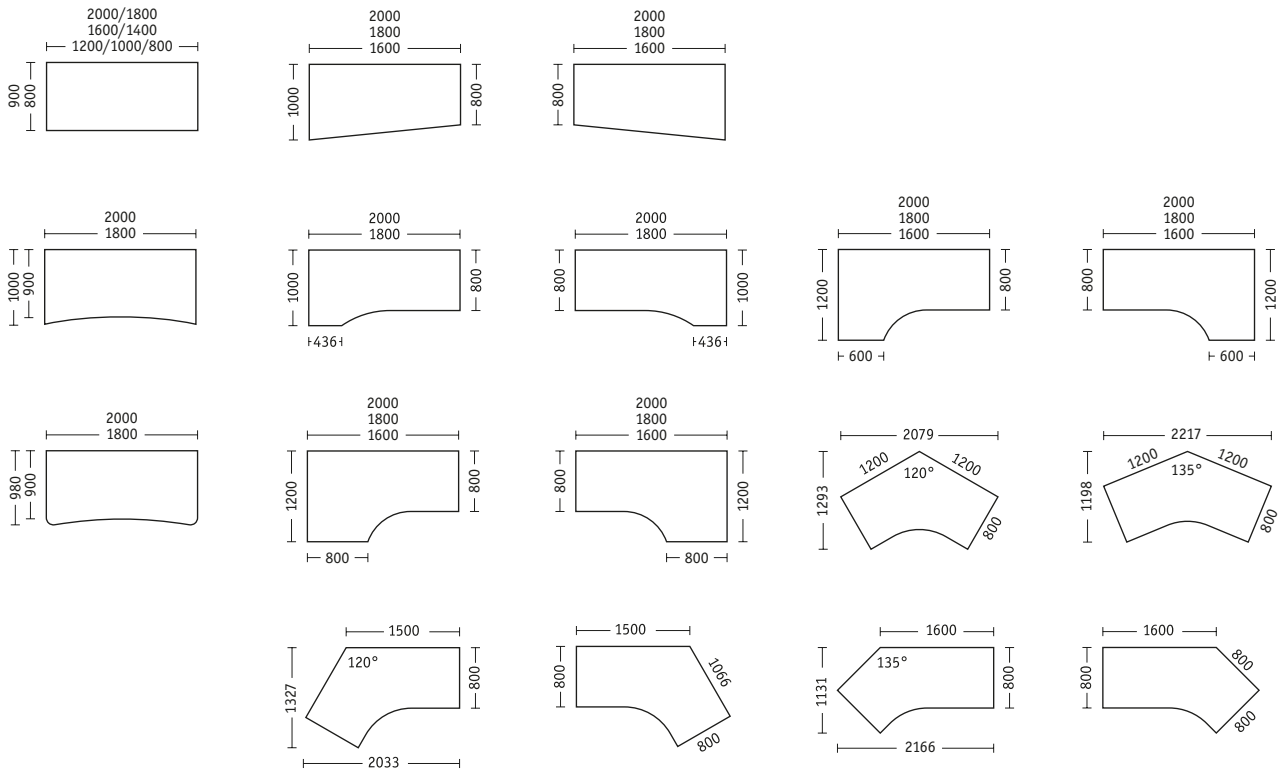

Returntables

Extension shelf

Side tables

Linear desks

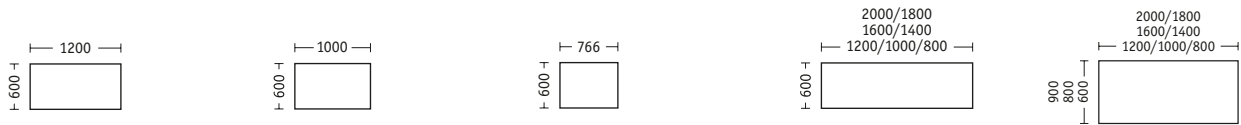

Add-ons

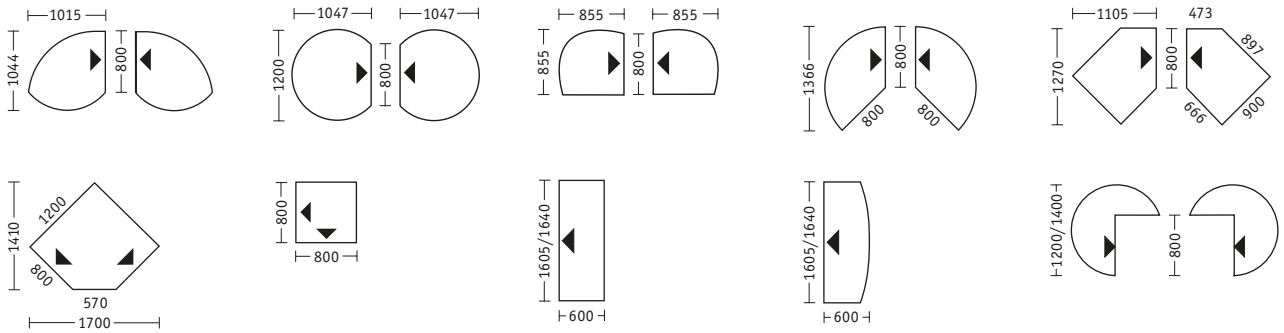

Conference tables

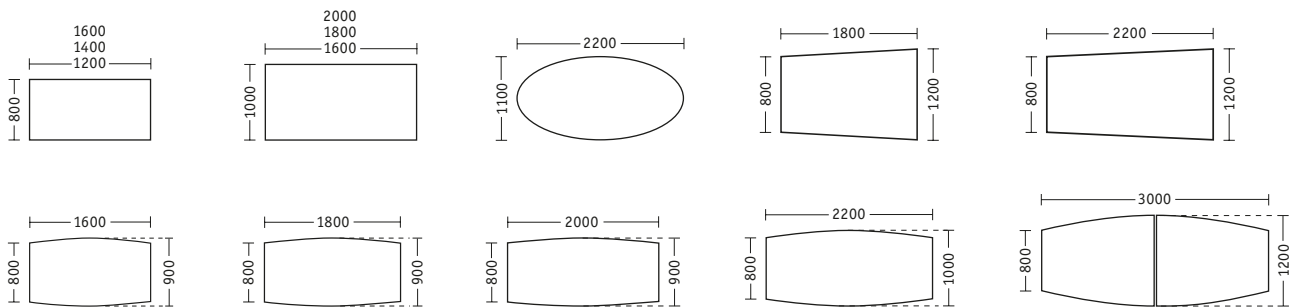

Dimensions in mm

Veneers



C11 Oak natural



C17 Oak wenge varnish



C19 Rustic beam oak light



C20 Rustic beam oak dark



D14 Walnut smooth



D15 Walnut wild



D16 Walnut rustic

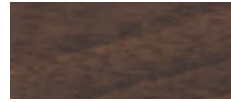

D11 Walnut dark



E41 Ash natural



E10 Ash white



E45 Ash black



B26 Beech natural



H11 Maple natural



H12 Heartwood maple natural



U10 Elm natural



Q10 Hickory natural

Melamine



K80 Ash light



K81 Oak light



K82 Oak natural



K83 Oak cognac



K84 Walnut natural

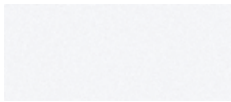

A14 pure white



K74 natural white

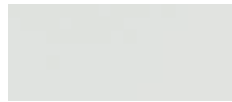

O2 arctic white



K70 graphite black



K77 light grey



K78 pebble grey



K79 stone grey



N10 likewood Oak natural



N11 likewood Oak lime washed

Side panels

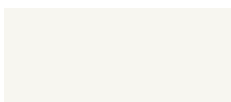

120 white



119 white aluminium



24 black

Modesty panels / desk screens plexiglass

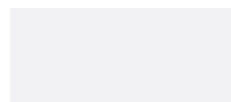

105 translucent white



122 kiwi (only modesty panel)

Foot supports



120 white



119 white aluminium



24 black



236 chrome-plated

3rd level

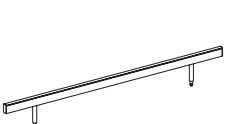

Function bridge

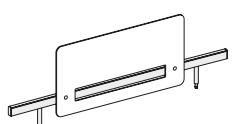

Plexiglass modesty screen



Flower vase



Cup holder

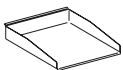

Storage tray DIN A4 portrait

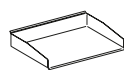

Storage tray DIN A4 landscape

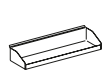

Pen tray landscape



Pen box



Notelet box for 90 x 90 mm

Sustainability down to the last detail.

Sustainability and “Made in Germany” quality have been key company principles at Sedus for more than 50 years. Principles that Sedus *temptation c* also embodies and which are reflected in recycling-orientated product design, ecologically tested materials, resource and energy-conscious manufacturing and ongoing quality tests. As an example, in the manufacture of the *temptation c* veneered table tops, only selected woods from sustainable forestry, such as beech, ash and oak, are used. Ultramodern, energy-saving and environmentally friendly production of the steel and aluminium components is also part of the quality and sustainability philosophy of Sedus. More information is available at www.sedus.com



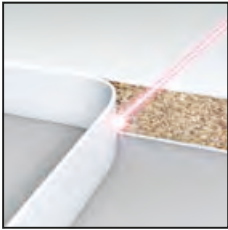

Innovative laser edge.
Jointless edge processing at the highest level that harmoniously combines durability, beauty and environmental friendliness.



Sustainable and close.
Real wood veneers from regional and sustainable forestry are not only fascinatingly beautiful, but also save transport kilometres.



Gentle protection. Instead of lacquer coating, Sedus relies on more environmentally friendly powder coating for finishing and to protect against rust.

Sedus operates globally in accordance with the principles of the UN Global Compact on human rights, labour standards, environmental protection and fighting corruption.



Company:



Sedus temptation c:



sedus

www.sedus.com

sedus

temptation
smart twin

Smart simplicity
Double comfort

**Double workstation
with linear configuration
for space-efficient use**

**Sensitive impact protection
as standard**



**Maximum legroom especially when
set up in rows thanks to the leg frame
without foot support**

**Team workplace to meet
the most ergonomic demands –
motorised height adjustment
from 650 – 1280 mm**

**Future-proof use as
it can be converted into
two individual desks**

**Intelligent concept enables
electrification deep inside
the room – flexible connection
with floor outlet boxes**



Programme range

- Depths: 1700 and 1900 mm (2 x 800/900 mm + 100 mm gap)
- Widths: 1400, 1600, 1800, 2000 mm
- Frame colours: white, white aluminium and black
- Veneers and melamines
- Functional controls
 - Slim (slim design on the desk edge)
 - Up/down with display and USB charger (for charging smartphones with directly accessed)
 - Control element with display and 4-fold memory (for saving up to 4 positions / can be slid under the desk top)



Use

- as a classic double workstation or bench

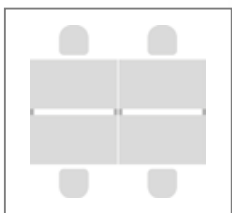

- as spine configuration

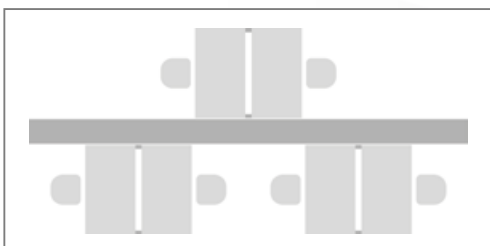

sedus

high desking





Into the future.

Places of inspiration instead of places just to work. With mastermind high desk and temptation high desk, Sedus is offering two separate ranges that combine all the advantages of modern high-desk concepts. Whether for temporary working, as a place for communication or as somewhere to meet during coffee breaks, they promote cooper-

ation and efficiency. The reason is that meetings in a standing position are livelier, usually take less time and are mostly more productive. At the same time, working at a high desk favours spontaneous changes of posture which have a positive effect on health.



Apart from this, mastermind high desk and temptation high desk can not only use spaces more efficiently but can also help to organise spaces in line with modern-day needs and sensibilities. This is a not-to-be-underestimated advantage when it comes to attractiveness as an employer.



mastermind high desk.
High desking in its most aesthetic form.



temptation high desk.
High desking with intelligent functionality.

Every team needs an identity: mastermind high desk.

mastermind high desk convinces at first glance thanks to a clear design that allows and encourages functional versatility. From the harmonious edge contours to the filigree legs, this high desk radiates a pleasantly restrained aesthetics. Understatement or style statement? In any case, a sophisticated design brought into focus by the premium materials and surfaces with which mastermind high desk can be individualised.



Handsome. The foot railing made of chrome-plated tubing, plus the corner and connecting nodes, together form a single unity that is harmonious in terms of design and functionality. The slim, conical legs give the silhouette its characteristic appearance and are attractive and distinctive features of mastermind high desk.



No cables, no frills. The optional electrification module that can be retro-fitted at any time is hidden beneath the desk top and can be slid from one end to the other.



Attractive. The appealing design allows the creation of meeting points where people like to get together – also in cafeterias and rest zones.

A good feeling. High quality down to the smallest detail. The shaped hand-made edges are pleasing to the eye and are soft to the touch. Up to nine careful work steps are needed to give mastermind high desk this very special finish.



Maximum functionality: temptation high desk.

Sedus temptation high desk was developed for all kinds of high-desking work. It is suitable as a meeting point in the middle zone of an office as well as a place of communication in entrance areas, showrooms, or recreational spaces. It brings an innate quality during presentations, meetings and brainstorming.

Among its greatest strengths are the numerous options with which temptation high desk can be fitted with for almost every task. This is possible on a larger scale as well: simple interlinking elements make it possible to create a long high bench from several individual high desks. What variant you decide on is up to you. temptation high desk can also be used to increase the efficient use of available space as it can be positioned in places that were previously unused.

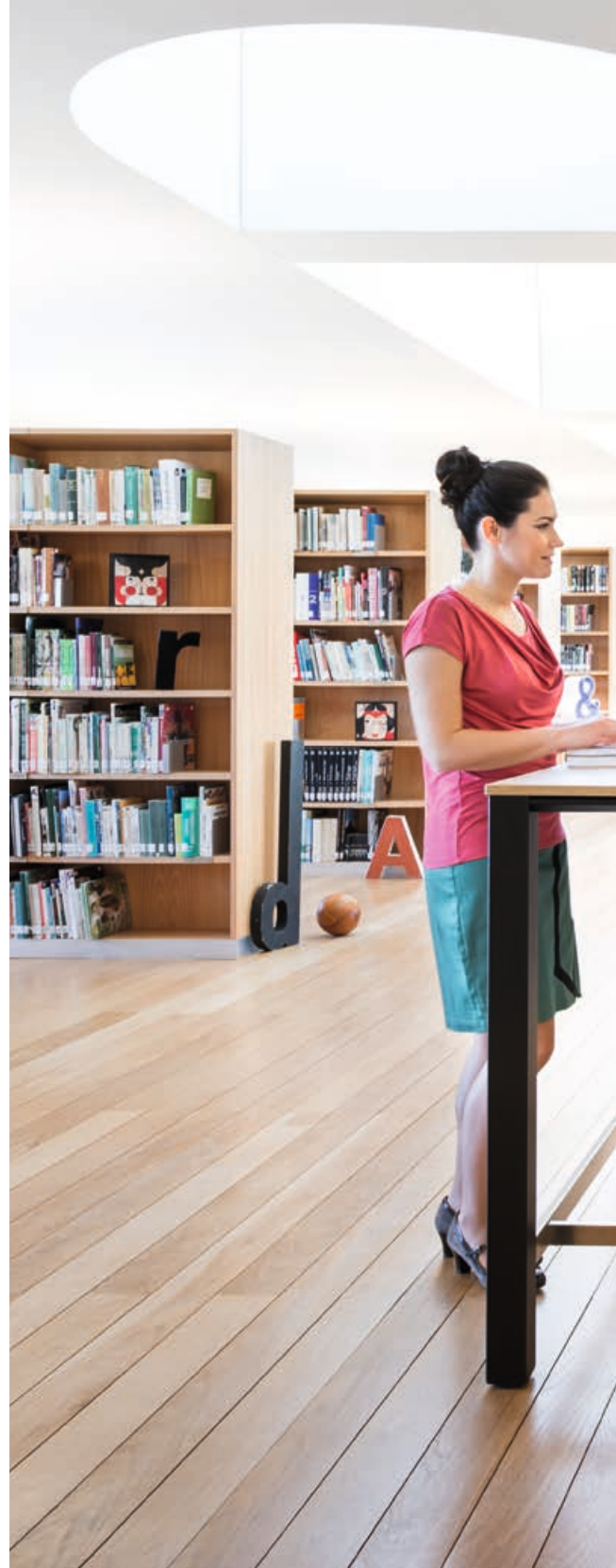

Always to hand. The integrated power, network and data interface enables very short set-up times and, together with the optional computer holders under the desk top, make for an uncluttered appearance.





Untiring. Standing restfully at a desk that is 1050 mm high or sitting comfortably thanks to the stainless-steel foot railing.



In the picture. Individual media equipment made easy. The mobile *monitor caddy* and the high desk with media wall, together with concealed cables, enable elegant mounting of the monitor.

Fully prepared for spontaneity.

Whether high desking with mastermind or with temptation, both models encapsulate the advantages of the high desk concept. Depending on the desired use, the two systems can be exactly equipped in the way that is best for the wellbeing and effectivity of the employees. The well thought-out accessories enable the workplace to be organised in such a way that new users wanting to work at the desk temporarily are given optimum support.



Useful. Most of the accessories can be attached to the optional multi-function rail without any tools. The entire width of the desk is therefore available for working.



Good team. In combination with the Organizer, the shell provides privacy and storage space.



Practical. The function bridge can be fitted with a large selection of accessories.



Variable. The "sail" screen and the monitor holder are adjustable according to the needs of very different users.



**Because life at work
is not a black-and-
white affair.**

Numerous surfaces, including exquisite real-wood veneers, underline the quality of mastermind high desk, mastermind flow and temptation high desk. They are also especially durable and can be attractively individualised.

Real wood veneer



C11 Oak natural



C17 Oak wenge varnish



C19 Rustic beam oak light



C20 Rustic beam oak dark



B26 Beech natural



D11 Walnut dark



D14 Walnut smooth



D15 Walnut wild



D16 Walnut rustic



H11 Maple natural



H12 Kernahorn natur



Q10 Hickory natural



U10 Elm natural



E10 Ash white



E41 Ash natural



E45 Ash black

Melamines



K80 Ash light



K81 Oak light



K82 Oak natural



K83 Oak cognac



K84 Walnut natura

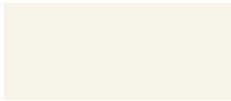

K74 natural white



K77 light grey



K78 pebble grey



K79 stone grey

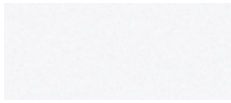

A14 pure white

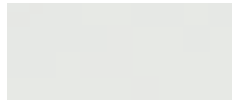

02 arctic white



K70 graphite black

Likewood Melamine



N10 Oak natural



N11 Oak lime washed

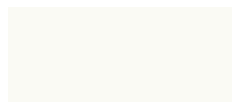

J10 white



J12 sand



J11 black

soft touch

Frames

Aesthetic. Strong steel-tube legs in white, white aluminium or chrome-plated ensure the stability of the mastermind and temptation desks.

temptation high desk

Fixed height. 1050 mm.



139 black



134 white



135 white aluminium

mastermind high desk

Height compensation. By means of plastic slides from 1050 to 1070 mm.



100 chromed



120 white



7902 beech



103 black



119 white aluminium



7903 oak



Typical mastermind. In addition, turned legs made of oak or beech are available.

High time for a comparison.



Designer piece. Sedus mastermind high desk is characterised by its clear aesthetics which, together with the high-quality materials, promise a very special work experience.

Multitalent. Sedus temptation high desk is unequalled when it comes to functionality and media integration. Moreover, several high desks can be linked together to make long high benches.



mastermind high desk



temptation high desk



Desk tops



Shaped edges

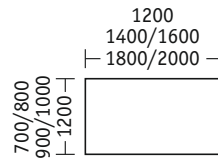
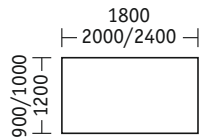

Media equipment

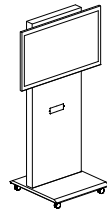

monitor caddy

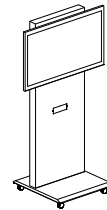

monitor caddy

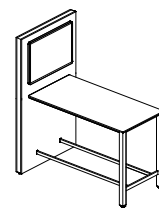

High desk with media wall

Accessories

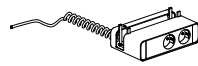

Electrification unit

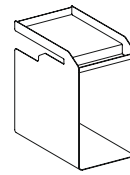

Smart Box Easy

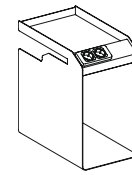

Smart Box Power

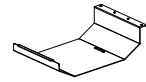

PC holder for mini PCs

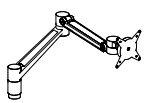

Monitor holder

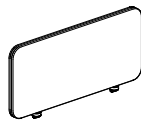

easy screen

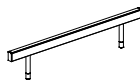

Function bridge

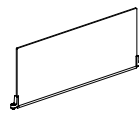

Plexi Screen

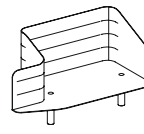

Organizer

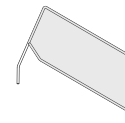

Sail screen

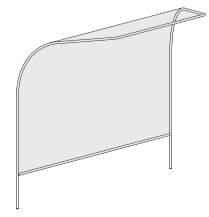

Shell screen



Coni. Optional, for individual access to power and data flows. Thanks to the brush strip, cables can be taken out even when the flap is closed.

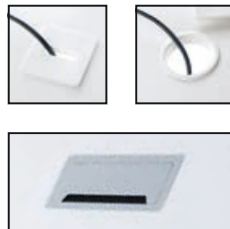

Cable openings. On request, for easy and elegant access to the electrification unit under the desk.



Socket point. Optional, small electrification unit needing little space.



Power Frame. Optional, easily accessible energy and data terminal with elegant mounting frame.



Netbox Turn. On request, for applications that require access from all sides. The rotary mechanism hides the terminals.



Company:

mastermind high desk:



www.tuv.com
ID 0000043152



Sustainability down to the smallest detail.

Sustainability and “Made in Germany” quality are among the central corporate principles that Sedus has adhered to for more than 50 years. Principles that the Sedus temptation high desk and mastermind high desk also embrace and that reflect recycling-oriented product design, ecologically tested materials, resource-sparing and energy-conscious manufacturing and permanent quality tests.

Solvent-free powder coating instead of conventional paint is therefore used to make the desks. The use of selected woods from sustainable local forests is also part of Sedus’ philosophy of quality and sustainability.

You will find more information at www.sedus.com

Innovative laser edge.

Superb seamless edging that combines robustness, attractiveness and environment-friendliness harmoniously.

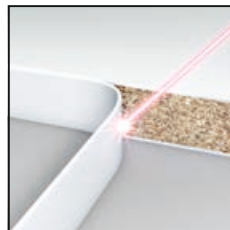

Sustainable and near.

Real-wood veneers from sustainable local forests are not only fascinatingly beautiful but also reduce the number of kilometres over which the wood has to be transported.



Powder coating instead of paint.

For finishing and as a protection against rust, we use high-quality powder coating, which is more environmentally compatible.



Around the world, Sedus adheres to the principles of the UN Global Compact for human rights, labour standards, the environment and anti-corruption.

temptation high desk:



sedus