

Desks

PRODUCT INFORMATION



ASSMANN

Contents

Canvaro **4**

Canvaro Compact **14**

Tensos **20**

Sympas **26**

Easy **34**

Pontis Hypa **38**

Rondana **44**

Antaro **50**

Solos **54**

Accessories **60**

Surfaces **62**

System overview **63**

Canvaro



Tried and tested, high-performance and always at the right height.
Equipped with electric or manual height adjustment for a simple switch
between seated and standing work positions.



Learn more
ass.al/xnr84tj

Quick and quiet adjustment to the right working height

The variant with a powerful and quiet electric motor (less than 45 dBA) moves at 50mm per second to reach the preferred working height in no time.



Electric height adjustment

Easy switch between a standing and seated work position.



Up/down operation



Up/down operation with LED display / 4 memory keys to save settings



Flexible uses

Canvaro delivers the right solution for any requirement. Whether as a highly functional and ergonomic single, double or group workspace.



T-leg frame type
Square tube
Height adjustment:
625 – 1275 mm



C-leg frame type
Round tube
Height adjustment:
635 – 1285 mm



C-leg frame type
Square tube
Height adjustment:
625 – 1275 mm

Smart workspace connectivity

The Applica docking system is available as an optional extra for the Canvaro desks. The innovative cable management system provides a broad range of options for connecting the data network and power supply.

Ports and cable management

The Applica docking system comes with individually assignable ports for all kinds of mobile devices to ensure neat cable management.



USB, VGA, RJ45



Schuko socket/
mains switch





For individual requirements

A large range of accessories and add-ons such as the Pontis technical container, the sound-absorbing Viteco privacy and partition walls or the Flexter organisation rail accommodate almost any conceivable requirement for individual workspaces.



Perfectly organised: With the Flexter organisation rail



Working in peace: Viteco partition walls for improved room acoustics

Incredible variety

The full and varied selection of surfaces and colours enable individual planning and furnishing, along with numerous design options.



Manual height-adjustment

The height of the table top can be adjusted individually to suit the particular user.

*The mode of height adjustment depends on the frame variant (round or square tube).



Stylish levers*

Tension levers are used to adjust the table height entirely without tools. The levers are delivered in the frame colour. Optionally available with gas spring operation.



Allen key*

Individual adjustment of the table height by Allen key.



Height-adjustment crank*

The working height is adjusted using a crank, which is then tucked away beneath the table top.



Hygiene shield for infection control

The Canvaro desk system is optionally available with Viteco hygiene screen made of high-quality acrylic glass, making a valuable contribution to required hygiene protection measures in the workspace.



T-leg frame type
Square tube
 Height adjustment:
 620–860 mm



C-leg frame type
Round tube
 Height adjustment:
 Standard: 620–860 mm
 Crank: 620–870 mm



C-leg frame type
Square tube
 Height adjustment:
 Standard: 620–860 mm
 Crank: 620–870 mm

Furniture solutions for any requirement

The Canvaro product family delivers extensive solutions for all kinds of use cases. Meeting, seminar and conference tables are available in the same look, besides the desk system.



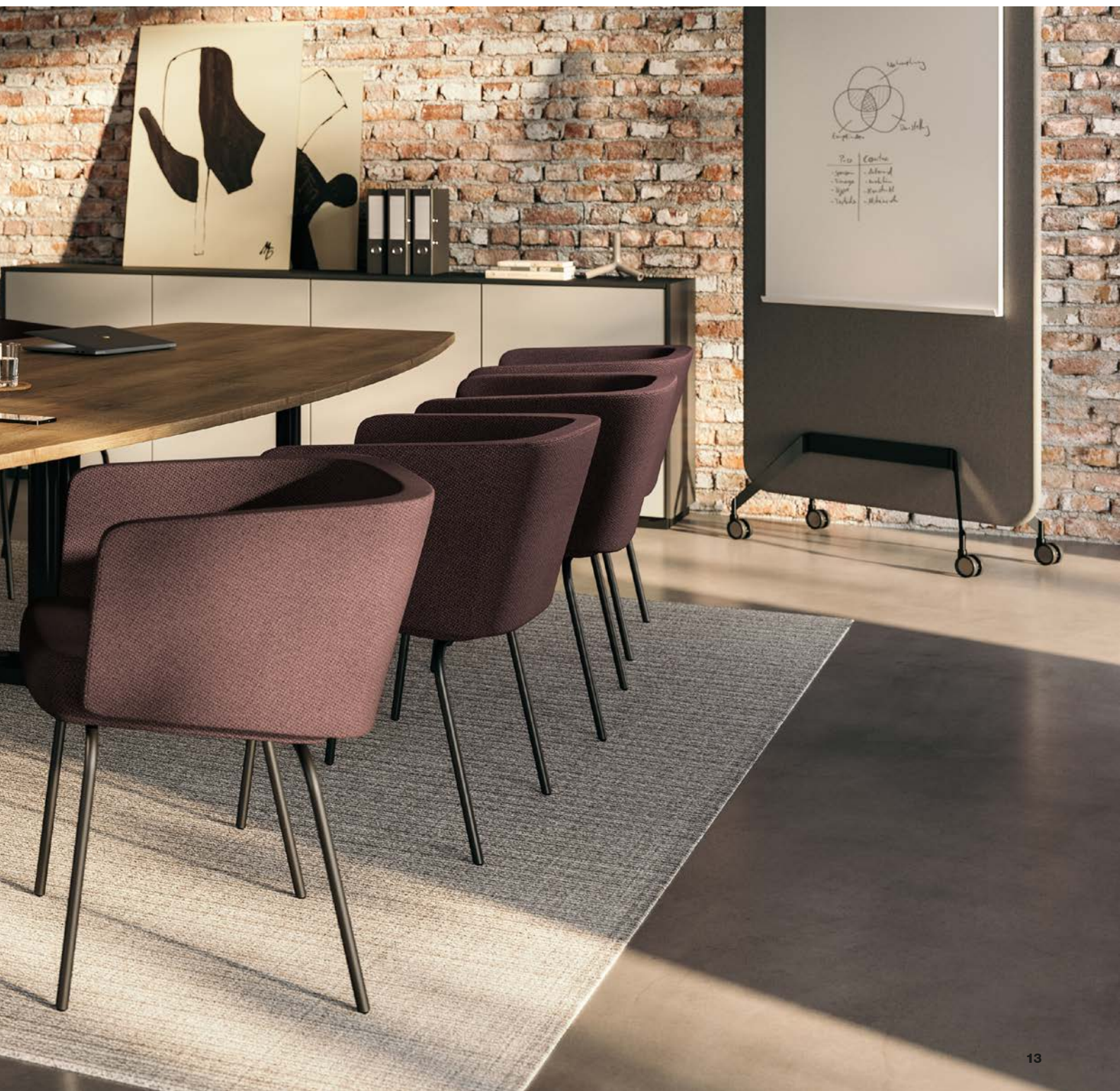

Canvaro Compact



The ideal desk system for use as a group workplace, Canvaro Compact offers practical flexibility for optimised space efficiency and a sit/stand function for ergonomic work. The desks can be retrofitted with table runners for easy conversion into single workplaces.



Learn more
ass.al/vlf89qj

Group workspace for unbeatable comfort.

Canvaro Compact ensures practical flexibility and comes with a sit/stand function for optimised ergonomics. Built for innumerable configuration options, the desk system enables a wide variety of design solutions for individual requirements.



Electric height-adjustment

Electric adjustment for individual working heights.



Up/down operation



Up/down operation with LED display / 4 memory keys to save settings



T-leg frame type
Square tube
Height adjustment:
625 – 1275 mm



Flexible add-ons

Canvaro delivers the right solution for any requirement. Whether as a highly functional and ergonomic single, double or group workspace.



Ergonomic work: Individual height adjustment

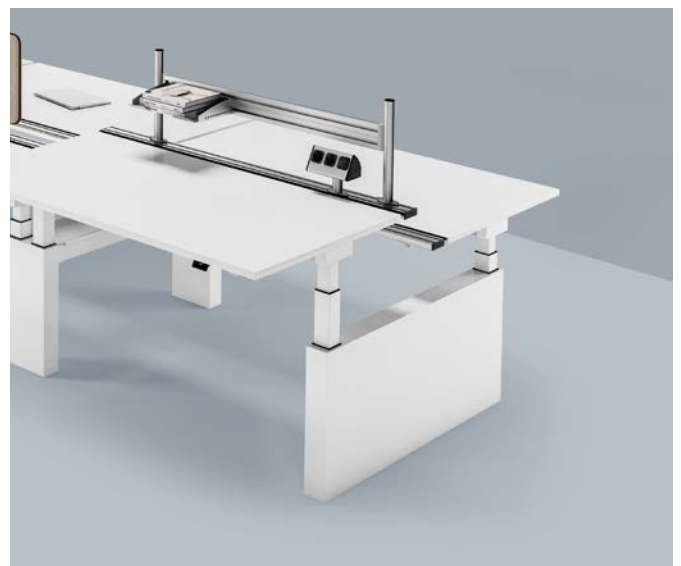

Clever: Neat workspaces with the Flexter organisation rail

Teamwork

Canvaro Compact creates a perfect environment for creative communication and is the ideal furnishing solution for open space teamwork as a double workspace or bench.



Manually height-adjustable

The height of the table top can be adjusted manually to suit the particular user.



Allen key
Individual adjustment of the table height by Allen key.



T-leg frame type
Square tube
Height adjustment: 620–860 mm



Workspace design for flexible requirements

The bench system adapts quickly and easily to changing requirements, creating individual workspaces and larger or smaller work islands without much effort. The leg frame can be optionally equipped with attractive side panels to conceal untidy cables.



Smart solution: Exposed cables can be tucked away neatly in the cable duct.



Added comfort: Open space container for practical storage

Tensos



The Tensos sit-stand desk system blends ergonomics with modern design and comes with electric height adjustment for maximum flexibility in selecting the ideal standing or seated work position.



Learn more
ass.al/mtxlrje

The perfect blend of design and function

The stylish and height-adjustable desk catches the eye with its slender T-leg frame and comes with a wide variety of table top shapes and optional add-ons.



Electric height-adjustment

Easy switch between a standing and seated work position.



Up/down operation



Up/down operation with LED display



Up/down operation with LED display / 4 memory keys to save settings



Up/down operation with LED display / 4 memory keys to save settings and a USB port



Ergonomic and flexible work

The sit-stand desk system can be combined and extended with an optional attachment solution for conferences. Available with a variety of frame variants, the table series is designed to accommodate specific requirements.



T-leg frame type
Round tube
 Height adjustment:
 620–1270 mm



T-leg frame type
Square tube
 Height adjustment:
 620–1270 mm



T-leg frame type
Rectangular tube
 Height adjustment:
 620–1270 mm

Versatile uses

Tensos is the perfect furniture solution for all kinds of office spaces. Whether in a single or group office, an open space or for working from home – the highly attractive desk slips easily into many different plans and designs to meet individual preferences and requirements.

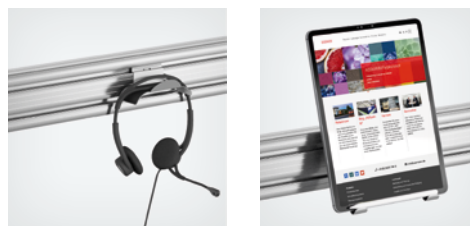

Well organised:
The Flexter organisation rail enables flexible workspace organisation.





Smart solution for workspace connectivity

Tensos is optionally available with the Applica docking system for tidy cable management and optimised connections to the data network and power supply.



Working from home: For ergonomic home workspaces



Pared-down design: Ideal integration in any room concept

Sympas



Sympas catches the eye with its clear structures and versatile use cases. The desk system is available in sit-stand or sit-down versions and delivers excellent value for money.



Learn more
ass.al/v5rf3hf

Individual and versatile

The clear design of the proven desk system slips easily into any room concept and accommodates flexible scenarios for use. As a sit/stand desk, Sympas comes with improved adaptability and ergonomics.



Electric height-adjustment

Easy switch between a standing and seated work position.



Up/down operation



Up/down operation with LED display



Up/down operation with LED display / 4 memory keys to save settings



Up/down operation with LED display / 4 memory keys to save settings and a USB port



Undisturbed work

Sympas harmoniously fits into open-plan work areas and is optionally available with Viteco partition walls for improved room acoustics.



T-leg frame type
Rectangular tube
Height adjustment:
620 – 1270 mm



Functional and attractive: Viteco partition walls

Clear and timeless design

The beautifully designed and manually height-adjustable desk system comes with three different frames for an individual look – from the classic 4-leg frame to the T-leg with round or square tubes. A variety of table top shapes are also available.



Manually height-adjustable

The height of the table top can be adjusted manually to suit the particular user.



Allen key
Individual adjustment of the table height by Allen key.



Tool-less height adjustment
Rotating plastic inserts are used to adjust the table top to the ideal height.



Allen key
Individual adjustment of the table height by Allen key.



Individually plannable

Sympas comes in a pared-down design that adapts seamlessly to any room concept. A large range of add-ons and a variety of table top shapes, leg colours and décors permit individual designs.



T-leg frame type
Round tube
 Height adjustment
 by adjustment screw:
 650–850 mm



T-leg frame type
Square tube
 Height adjustment
 by adjustment screw:
 650–850 mm



4-leg frame type
plastic leg
Left: Round tube
Right: Square tube
 Height adjustment:
 680–820 mm



4-leg frame type
tube-in-tube
Left: Round tube
Right: Square tube
 Height adjustment:
 650–850 mm

The right solution for any requirement

Sympas delivers incredible product variety. Besides the desks, the family includes bistro tables for common and break rooms, as well as meeting and conference tables.





Easy



The height-adjustable Easy desk is a basic model that comes with the benefits of a sit/stand desk and is reduced to the bare essentials with its rectangular table top and selected accessories.



Learn more
ass.al/i4saqbz

Ergonomic work

Easy is equipped with electric height adjustment to enable a quick and simple switch from a standing to seated work position and is therefore ideally suited as a healthy and ergonomic option for office or home workspaces.



Electric height-adjustment

The desk system is adjusted to the ideal working height at the push of a button.



Up/down operation



Up/down operation with LED display / 4 memory keys to save settings



T-leg frame type
Rectangular tube
Height adjustment:
650–1250 mm



Ergonomic work has never been this easy

The desk system catches the eye with its functional design and is the cost-efficient option for furnishing ergonomic workspaces.



Sound-absorbing effect: with the Viteco partition walls



Attractive: practical knee room panel for improved privacy

Pontis Hypa



The new battery-powered and height-adjustable Pontis Hypa table series delivers a variety of options for every requirement. A truly multifunctional option, the TÜV-certified tables enable limitless and creative use of the available space.



Learn more
ass.al/g40ibee

Maximum flexibility

Whether as a desk, seminar or bistro table – the electrically height-adjustable Pontis Hypa tables are optimised for ergonomic work in a standing or seated position. Fitted with casters, the tables can be moved quickly and easily to any location for flexible use.



Electric height-adjustment

Easy switch between a standing and seated work position.



Up/down operation



Up/down operation with LED display



Up/down operation with LED display / 4 memory keys to save settings



Up/down operation with LED display / 4 memory keys to save settings and a USB port



Battery-powered, height adjustable sit/stand desk and bistro table

The Pontis Hypa tables are equipped with a high-end rechargeable battery with enough power for an entire working week and enables up to 50 cycles for changing between standing or seated work positions for unbeatably healthy and ergonomic work.



Frame type
Round tube
Height adjustment:
720–1370 mm



Charged USB port for convenient smartphone charging

Multifunctional and compact:

The desk and seminar table is fitted with a folding table top to enable stacking after use and efficient storage. This improves the options for optimised use of the available space. Equipped with casters, Pontis Hypa tables are easy to move to accommodate individual space requirements and room layouts.



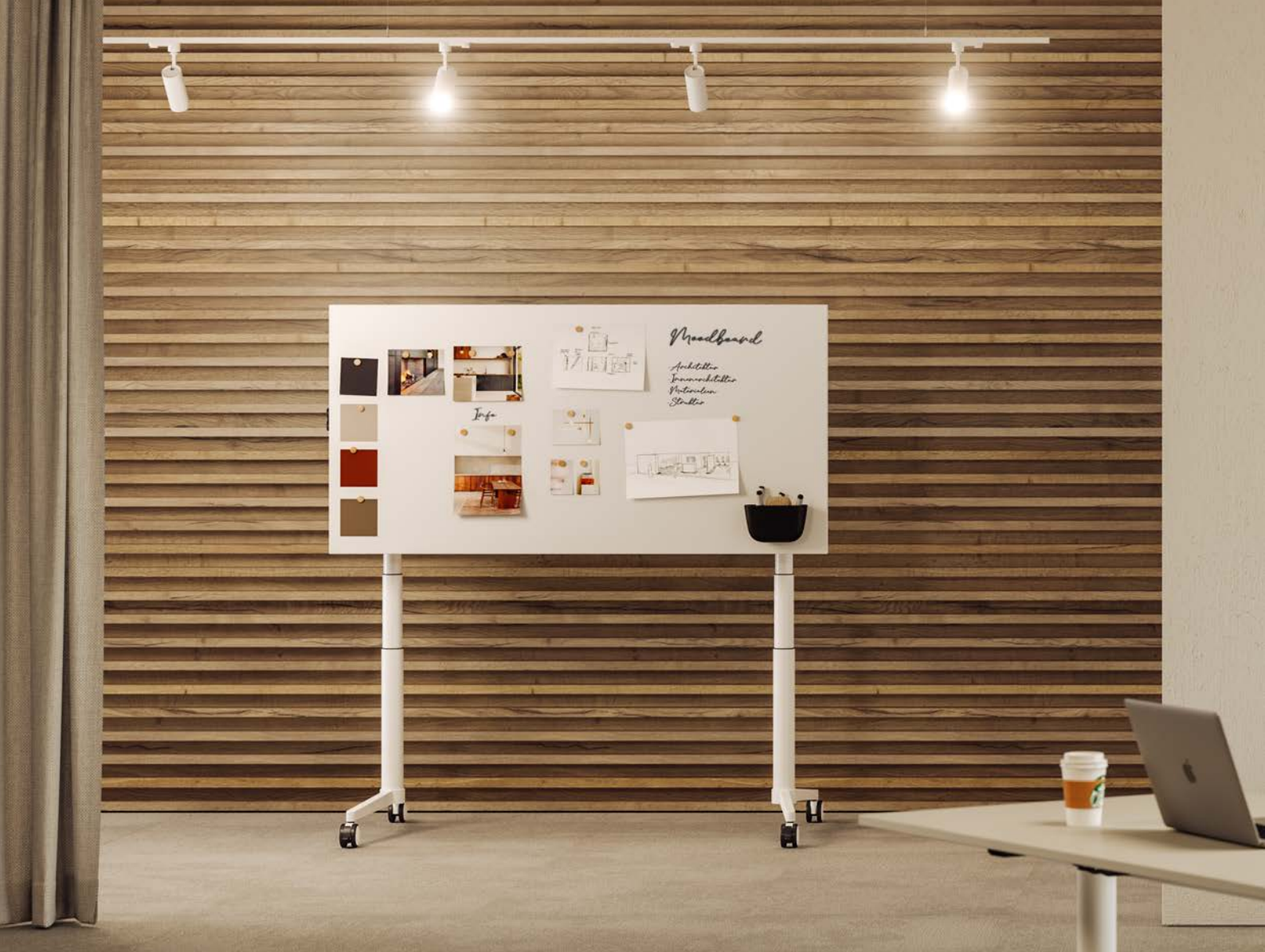

For improved creativity

The folding table top is optionally available as a writable or magnetic whiteboard for more agility in group brainstorming sessions during workshops.



Space-saving: Folding table top for stacked storage



Magnetic storage box: With a range of accessories

Rondana



The Rondana desk system has a discreet look that slips easily into any arrangement. The various table top shapes also accommodate versatile planning and design options for a wide range of requirements.



Learn more
ass.al/82hnz3h

Individual and flexible

The Rondana desks catch the eye with their stylish design, numerous surface options and various table top shapes.

Create order:
Everything in its right place with the Flexter organisation rail



Manually height-adjustable

The height of the table top can be adjusted manually to suit the particular user.



Tool-less height adjustment
Rotating plastic inserts are used to adjust the table to the optimum height.

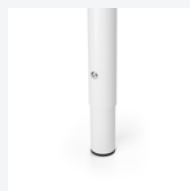

Allen key
Individual adjustment of the table height by Allen key.



Connectivity and functionality

The Rondana desk system can be combined with the Applica docking system to ensure smart workspace connectivity in an attractive design.



Simple: Modern furniture solution for open space work

Suits any work environment

The Rondana desks enable versatile use cases – whether as conference tables and as single or double workspace solutions. They are predestined as functional additions to training and seminar spaces when combined with the Applica docking system.





Antaro



The Antaro desk system marries attractive design with clever functionality. Available with numerous and customisable table top shapes as well as premium frame variants, it is a tasteful furnishing solution for the most discerning users.



Learn more
ass.al/nqdiq50

Stylishly matched

Besides the attractive look, the Antaro catches the eye with its versatile uses – whether as a single or double workspace solution or as a conference table.



Manually height-adjustable

The height of the table top can be adjusted manually to suit the particular user.



Tool-less height adjustment
Rotating plastic inserts are used to adjust the table to the optimum height.



Allen key
Individual adjustment of the table height by Allen key.



Individual and versatile

The Antaro desk system comes in a wide range of materials for numerous planning and design scenarios to deliver furnishing solutions for any requirement.



**4-leg frame type
plastic leg**
Left: Round tube
Right: Square tube
Height adjustment: 680–820 mm

**4-leg frame type
tube-in-tube**
Left: Round tube
Right: Square tube
Height adjustment: 620–850 mm



Flexible: Workspace extension with the Pontis side table

Solos



The Solos desks catch the eye with their elegant and purist design, high-quality materials, a suspended table top look and a slender and discreetly elegant leg frame.



Learn more
ass.al/5u2zz0s

Modern design

The pared-down engineering and unique design of the Solos raise the bar for attractiveness and functionality – whether as a single workspace in the director's office or group workspaces in open-plan areas.



Manually height-adjustable

The height of the table top can be adjusted manually to suit the particular user.



Allen key
Individual adjustment of the table height by Allen key.



Tool-less height adjustment
A folding lever is used to adjust the table height entirely without tools.



4-leg frame type Rectangular tube
Height adjustment: 650–850 mm



4-leg frame type Rectangular tube
Fixed table height: 740 mm



Modern solutions for various work configurations

Whether as a modern group space for inspirational teamwork or an elegant individual desk for periods of focus – the Solos desks are always a modern and attractive solution for any kind of requirement.



Optimised configuration: For a stylish office at home



Function: L-shaped connections for additional workspace

Versatile work areas

Solos includes a broad range of products. Besides the desks, the family also includes modern meeting and conference tables. Whether as stylish conference tables, high desks for meetings or even in break and common rooms – the Solos tables will turn heads with their multiple variants and modern design.





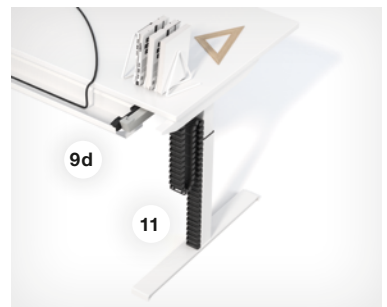
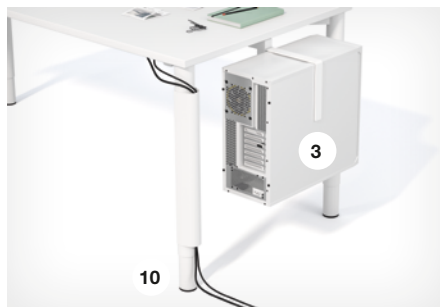
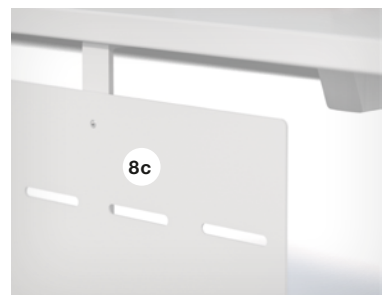
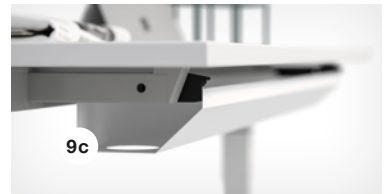
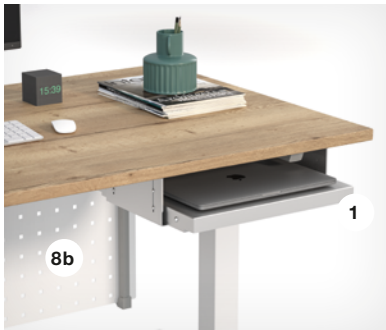
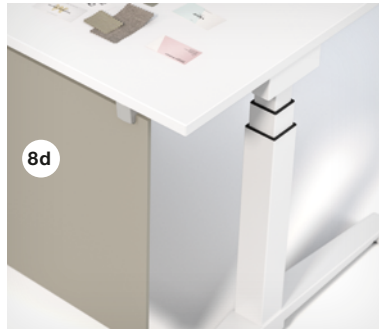
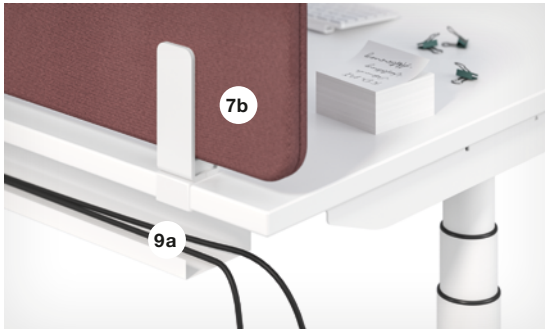
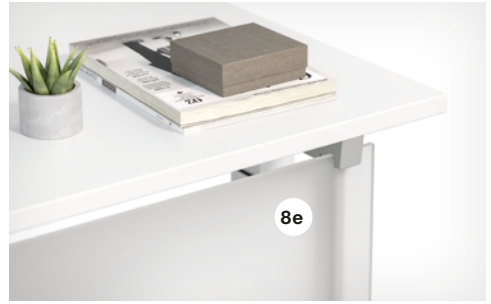
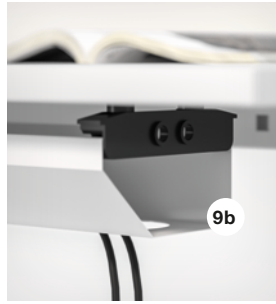

Accessories

	Canvaro	Canvaro Compact	Tensos	Sympas	Easy	Rondana	Antaro	Solos
① Horizontal laptop tray/ laptop mount	✓	✓	✓	✓	✓			
② PC mount for sit/stand workspaces	✓	✓	✓	✓	✓			
③ PC table top mount fitted to the upper frame/ table top	✓	✓	✓	✓		✓	✓	✓
④ PC table top mount fitted to the frame leg	✓	✓	✓	✓		✓	✓	
⑤ Applica docking system	✓		✓			✓	✓	
⑥ Flexter organisation rail	✓	✓	✓			✓	✓	✓
⑦ Viteco privacy and partition walls								
a) Clamp mounting	✓	✓	✓	✓	✓	✓	✓	✓
b) Mounted on the upper frame	✓	✓	✓	✓		✓	✓	✓
⑧ Knee room panels*								
a) Metal panel, round holes, Flex and frame	✓	✓	✓			✓	✓	✓
b) Metal panel, square holes, Flex and frame	✓	✓	✓			✓	✓	✓
c) Metal panel, slotted holes, Fix			✓	✓	✓			
d) Wood panel, Fix, Flex, Frame	✓	✓	✓	✓	✓	✓	✓	✓
e) Satin glass panel, Flex and Frame	✓	✓	✓			✓	✓	✓
⑨ Horizontal cable duct								
a) Fix, mounted on the table top			✓	✓	✓			
b) Flex, mounted flexibly on the table top, folding	✓	✓	✓	✓	✓	✓	✓	✓
c) Frame, mounted on the upper frame, folding	✓	✓	✓	✓**		✓	✓	✓
d) Slide, mounted on the upper frame with sliding panel function, folding	✓	✓	✓	✓**		✓	✓	✓
⑩ Vertical cable duct	✓	✓	✓	✓	✓	✓	✓	✓
⑪ Vertical cable routing for sit/stand desks	✓	✓	✓	✓	✓			
⑫ ASSMANN SMART	✓	✓	✓	✓	✓	✓	✓	✓
⑬ Organisation box – felt	✓	✓	✓	✓	✓	✓	✓	✓
⑭ Orga Work	✓	✓	✓	✓	✓	✓	✓	✓
⑮ Organisation box – plastic	✓	✓	✓	✓	✓	✓	✓	✓

* The knee room panels are available in different versions:

- Fix, mounted on the table top
- Flex, mounted flexibly on the table top
- Frame, mounted on the upper frame

**Sit/stand tables only

Surfaces

Decor

BASIC Canvaro | Canvaro Compact | Tensos | Sympas | Easy | Pontis Hypa | Antaro | Rondana | Solos



Maple Beech Cherry malaga Ferrara oak Acacia Walnut



Flint Black Slate Light grey Metallic silver Anthracite



Basalt Mist grey Grey white Signal white

PREMIUM Canvaro | Canvaro Compact | Tensos | Sympas | Easy | Pontis Hypa | Antaro | Rondana | Solos



Tobacco oak Natural oak Polar oak Exposed concrete light grey Exposed concrete anthracite

Veneers

Canvaro | Canvaro Compact | Tensos | Easy | Antaro | Rondana | Solos



Natural-birch Natural ash Natural oak Natural-beech Pear tree

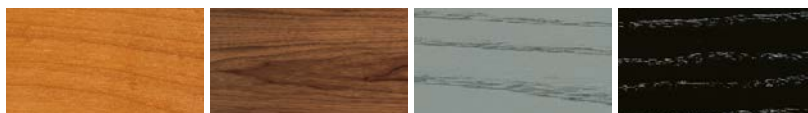

Cherry Walnut Grey ash Black ash Other veneers on request

Frame colours

Canvaro | Canvaro Compact | Tensos | Sympas | Easy | Pontis Hypa | Antaro | Rondana | Solos



Signal white** Grey white White aluminium Anthracite-grey Black** Chrome*

* Only available for Solos

** Only available for STS tables in the Sympas series.

System

Tables

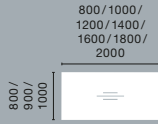
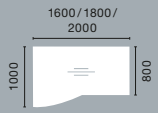
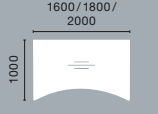
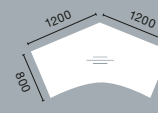
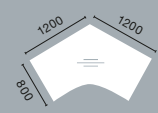
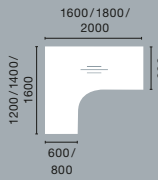
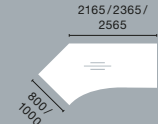
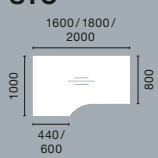
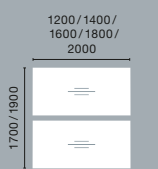
	Canvaro	Canvaro Compact	Tensos	Sympas	Easy	Rondana	Antaro	Solos
ST 	✓			✓		✓	✓	✓
STB 	✓			✓		✓	✓	✓
STCP 	✓			✓		✓	✓	✓
STDR12124/135° 	✓			✓		✓	✓	✓
STDR12126/120° 	✓			✓		✓	✓	✓
STL 	✓			✓		✓	✓	✓
STP 	✓			✓		✓	✓	✓
STC 	✓			✓		✓	✓	✓
Bench 		✓						



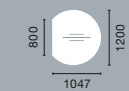
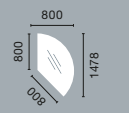
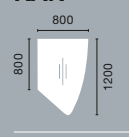
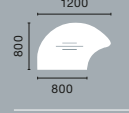
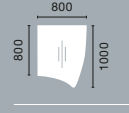
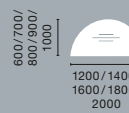
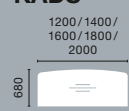

Conference add-ons

	Canvaro	Canvaro Compact	Tensos	Sympas	Easy	Rondana	Antaro	Solos
KAB 	✓			✓		✓	✓	✓
KAC 	✓			✓		✓	✓	✓
KAL 	✓			✓		✓	✓	✓
KAT 	✓			✓		✓	✓	✓
KA2T 	✓			✓		✓	✓	✓
KAN 	✓			✓		✓	✓	✓
KAP 	✓			✓		✓	✓	✓
KAW 	✓			✓		✓	✓	✓
KAZ 	✓			✓		✓	✓	✓
KAD 	✓			✓		✓	✓	✓
KADS 	✓			✓		✓	✓	✓



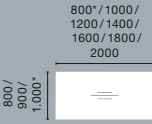

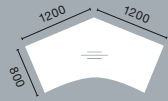
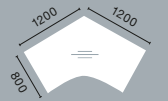
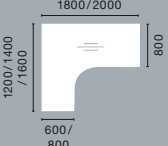
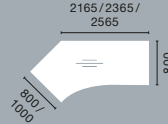
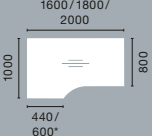

All info is subject to change. Refer to the electronic planning data for information about the variants and sizes. All dimensions in mm.

System

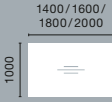
Sit/stand tables

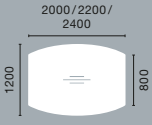
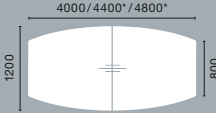
	Canvaro	Canvaro Compact	Tensos	Sympas	Easy	Rondana	Antaro	Solos
STS  <p>*Not available for Easy</p>	✓		✓	✓	✓			
STSB 	✓		✓	✓				
STSCP 	✓		✓	✓				
STSDR12124 / 135° 	✓		✓					
STSDR12126 / 120° 	✓		✓					
STSL 	✓		✓					
STSP 	✓		✓					
STSC  <p>*Not available for Tensos</p>	✓		✓	✓				
Bench 		✓						

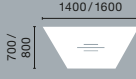



Conference tables

	Canvaro	Canvaro Compact	Tensos	Sympas	Easy	Rondana	Antaro	Solos
BT 	✓			✓		✓	✓	✓
BTOV 	✓			✓		✓	✓	✓
BTEP 	✓			✓		✓	✓	✓
BTR 	✓			✓		✓	✓	✓
BTR2  <p>*Only for Solos</p>	✓					✓	✓	✓
BRR 	✓					✓	✓	✓
BR 	✓					✓	✓	✓
BTK 						✓	✓	✓
BG 	✓					✓	✓	✓

Connecting elements

	Canvaro	Canvaro Compact	Tensos	Sympas	Easy	Rondana	Antaro	Solos
VE08EF 	✓			✓		✓	✓	
VE45VT 	✓			✓		✓	✓	
VE60VT 	✓			✓		✓	✓	
VE90 	✓			✓		✓	✓	
VE12EF 	✓			✓		✓	✓	
VE1210TR 	✓			✓		✓	✓	
VE90RVT 	✓			✓		✓	✓	
VE12EFRVT 	✓			✓		✓	✓	
VE60DR 	✓			✓		✓	✓	
VE1208TR 	✓			✓		✓	✓	

Extension solutions

	Canvaro	Canvaro Compact	Tensos	Sympas	Easy	Rondana	Antaro	Solos
Device table ST06 800/1000/1200/ 1400/1600/ 1800/2000 	✓			✓		✓	✓	✓
Partition board ZP 800/1000/1200/ 1400/1600/ 1800/2000 600/800/ 900/1000/ 1200 	✓					✓	✓	
Trapezoid element TT0808 800 	✓					✓	✓	
Trapezoid element TZ0808 800 	✓					✓	✓	

Pontis Hypa

KTSA

1400/1600/1800





Award-winning GOOD WORK

We always adhere to the highest standards in our work – whether it's product quality, services or responsible treatment of the environment and natural resources. Along with the quality and safety certifications, our product and sustainability awards confirm that design, unbeatable quality and the use of harmless materials are indispensable attributes in the creation of modern worlds of work.



Furniture solutions and services from a single source

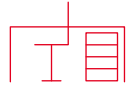

Desks

Modern design, a range of variants and tested quality, combined with optimised functionality and flexible height settings for ergonomic workspaces.

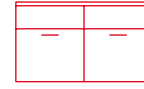

Storage space

Furnishing solutions for room design with functional storage space, modern wall shelves, secure locker cabinets and flexible container systems.



Office swivel chairs

Comfortable and ergonomic seating quality, attractively modern and clear design and easy handling with a broad selection of choice of colours and surfaces.

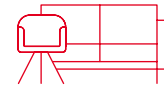

Seats

High-quality armchairs, cosy sofas, modern and stackable multi-purpose chairs and freely combinable seating modules with optimised seating comfort and an unlimited range of colours and variants.



Lounge furniture

Open and closed room-in-room meeting and communication cubicles, flexible seating elements and comfortable lounge furniture in a variety of designs and surfaces.

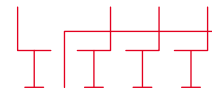

Seminars and meetings

Flexible and functional furnishing solutions for meetings, seminars and conferences with customisable versions and flexible combination options.

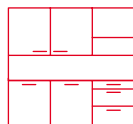

Office kitchens

Modern and high-quality kitchens with optimised functionality and plenty of storage space options, high-quality fittings and a wide range of design variants.



Reception

Modular, individually plannable reception and counter systems to design the reception area with customisable surfaces and practical additional functions.



Room acoustics

Acoustically effective furnishing solutions with attractive finishing, matching components and partition screen systems to improve room acoustics.

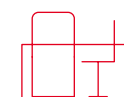

Components

Innovative docking systems, multifunctional organisational rails and partition wall systems for acoustic and hygiene requirements in a variety of designs and surfaces.



Booking systems

Smart office solutions for organising office workspaces based on sensor-supported booking systems and software-controlled locker systems.



Services

End-to-end consulting and planning services to design and create modern worlds of work with complementary pre- and after-sales support.

ASSMANN BÜROMÖBEL GMBH & CO. KG

Heinrich-Assmann-Strasse 11
D-49324 Melle

Postfach 1420
D-49304 Melle

Phone +49 (0)5422 7060

info@assmann.de
www.assmann.de

